



	Classe II. Apparecchio nel quale la protezione contro la scossa elettrica non si basa unicamente sull'isolamento principale ma anche sulle misure supplementari di sicurezza
	Protezione contro l'ingresso di corpi solidi di Ø 12 mm. Nessuna protezione contro la pioggia. Marcatura non prevista sull'apparecchio.
	ATTENZIONE L'apparecchio non deve essere smaltito come rifiuto urbano. Deve essere soggetto a raccolta separata per evitare danni all'ambiente. Nel rispetto della Direttiva 2012/19/UE e delle Leggi nazionali adottate per lo smaltimento del prodotto a fine vita. Il mancato rispetto di quanto sopra è sanzionato dalla Legge. Si prega di informarsi in merito al sistema locale di raccolta differenziata per i prodotti elettrici ed elettronici.

Max 9W	Potenza
220 / 240 V AC 50Hz	Tensione di funzionamento
Caratteristiche tecniche	

	Installazione, manutenzione dell'apparecchio e/o sostituzione delle lampadine/ sorgenti Led. Prima di qualsiasi operazione estrarre sempre la spina dalla presa di corrente e togliere l'alimentazione generale dell'impianto elettrico. Nel caso di installazione di sospensioni/applicare rivolgersi sempre a personale qualificato.
	Le parti che conducono corrente non devono entrare in contatto con l'umidità. Le superfici quali paralumi, vetri, riflettori e coperture possono essere pulite con un panno morbido senza detersivo. Proteggere la lampada dall'umidità durante l'uso.
	ATTENZIONE L'apparecchio non deve essere smaltito come rifiuto urbano. Deve essere soggetto a raccolta separata per evitare danni all'ambiente. Nel rispetto della Direttiva 2012/19/UE e delle Leggi nazionali adottate per lo smaltimento del prodotto a fine vita. Il mancato rispetto di quanto sopra è sanzionato dalla Legge. Si prega di informarsi in merito al sistema locale di raccolta differenziata per i prodotti elettrici ed elettronici.

CE LED IP 20

1 - Follow carefully the assembly and use instructions to guarantee a correct and safe function of the luminaire.

2 - Keep the instructions for future needs. For any problems, get in touch with your supplier.

3 - The product must not be modified. Any change will nullify the safety guarantees and may make the luminaire dangerous.

4 - Rotalliana declines all responsibility for damage caused to things or persons by any improper use of the luminaire.

5 - Refer to the website www.rotalliana.it for instruction on how to replace the power packs, the light sources, and on how to disassemble the product at the end of its lifecycle.

6 - This product contains an energy class F light source.

1 - Seguire attentamente le Istruzioni di montaggio e d'uso per garantire un funzionamento corretto e sicuro dell'apparecchio.

2 - Conservare le Istruzioni per future necessità. Per eventuali problemi contattare il rivenditore.

3 - Il prodotto non deve essere modificato. Qualsiasi modifica annulla le approvazioni di sicurezza e può rendere pericoloso l'apparecchio.

4 - Rotalliana declina ogni responsabilità per danni causati a cose o a persone da un non corretto uso dell'apparecchio.

5 - Fare riferimento al sito web www.rotalliana.it per le Istruzioni di sostituzione degli alimentatori, delle sorgenti luminose e disassemblaggio a fine vita del prodotto.

6 - Questo prodotto contiene una sorgente luminosa di classe energetica F.

1 - Bitte lesen Sie die Montage-und Gebrauchsanleitungen aufmerksam, um eine richtige und gefahrlose Arbeitsweise der Leuchte zu gewährleisten.

2 - Bewahren Sie die Anweisungen für zukünftige Notfälle auf.

3 - Das Produkt darf nicht verändert werden. Jede Änderung annulliert die Sicherheitsbestimmungen und könnte zu einer Gefährdung durch die Leuchte führen.

4 - Rotalliana ist nicht für Schäden verantwortlich, die durch Dritte bei unsachgemäßer Anwendung der Leuchte verursacht werden.

5 - Für die anleitungen bezüglich des austausches der netzteile und der lichtquellen demontage am ende der lebensdauer des produkts konsultieren sie bitte die website www.rotalliana.it.

6 - Dieses produkt enthält eine lichtquelle der energieklasse F.

1 - Suivre soigneusement les instructions de montage et utilisation pour garantir un correct et sur fonctionnement de l'appareil.

2 - Garder les instructions pour des futures nécessités. Pour tous problèmes, contacter le revendeur.

3 - Le produit ne doit pas être modifié. Toute modification annule les approbations de sécurité et peut rendre dangereux l'appareil.

4 - Rotalliana décline toute responsabilité pour les dégats causés choses ou personnes this une incorrecte utilisation de l'appareil.

5 - Reportez-vous au site la tolle www.rotalliana.it pour les Instructions de substitution des alimentateurs, des sources lumineuses et pour le démontage du produit en fin de vie.

6 - Ce produit contient une source lumineuse de classe énergétique F.

Rotalliana srl  
via Trento 115 - 117  
38017 Mezzolombardo  
Trento, Italia

T. +39 0461 602376  
info@rotalliana.it  
rotalliana.it

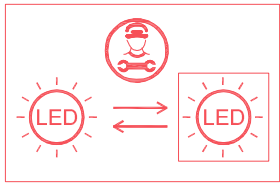

IT - LED sostituibile solo da personale specializzato.

EN - Replaceable (LED only) light source by a professional.

DE - Durch einem Fachmann austauschbare Lichtquelle (nur LED).

FR - Source de lumière remplaçable (LED) par un professionnel.

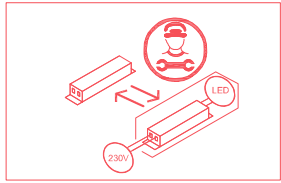



IT - Driver sostituibile solo da personale specializzato.

EN - Replaceable control gear by a professional.

DE - Durch einen Fachmann austauschbares Vorschaltgerät.



FR - Équipement de contrôle remplaçable par un professionnel.

Max 9W	Power
220 / 240 V AC 50Hz	Tension
Caratteristiche tecniche	

	Fitting and maintaining the unit and/or replacing the bulb. Led. Before doing anything, always remove the lamp plug from its socket or turn off the lamp supply circuit, and leave the bulb to cool. When fitting hanging lamps or fixtures always use qualified personnel.
	Parts that conduct current must not be exposed to humidity. Surfaces such as lampshades, glasses, reflectors and covers can be cleaned with a soft cloth but without using detergents. Protect the lamp from humidity during use.
	ATTENTION The product cannot be disposed as unsorted municipal waste. It must be collected separately to prevent negative environmental impacts. In accordance with the procedures of Directive 2012/19/UE and relevant national laws and regulations adopted pursuant to this Directive on the disposal of waste at the end of the life cycle of the product, any violation is sanctioned by law. Please inform yourself about the local separate collection system for electrical and electronic products.

CE LED IP 20

Max 9W	Power
220 / 240 V AC 50Hz	Tension
Caractéristiques techniques	

	Installation, entretien de l'appareil et/ou remplacement de l'ampoule/ Led. Avant toute opération, débrancher la prise de courant ou couper l'alimentation générale de la distribution d'électricité. L'installation des suspensions/applicatures doit être effectuée par personnel spécialisé.
	Index de protection IP 20. Protection contre l'entrée de corps solides de Ø ≥ 12 mm. Il n'y a aucune protection contre la pluie. Le marquage non prévu sur l'appareil.
	ATTENTION L'appareil ne doit pas être éliminé comme simple déchet urbain mais conformément à la collecte sélective pour garantir la protection de l'environnement. Conformément à la Directive 2012/19/UE et aux dispositions légales qui le transposent pour ce qui touche à l'élimination du produit au terme de sa durée de vie, les contrevenants aux dispositions en vigueur sont passibles des sanctions prévues par la loi. Veuillez vous informer du système local de séparation des déchets électriques et électroniques.

Rotalliana

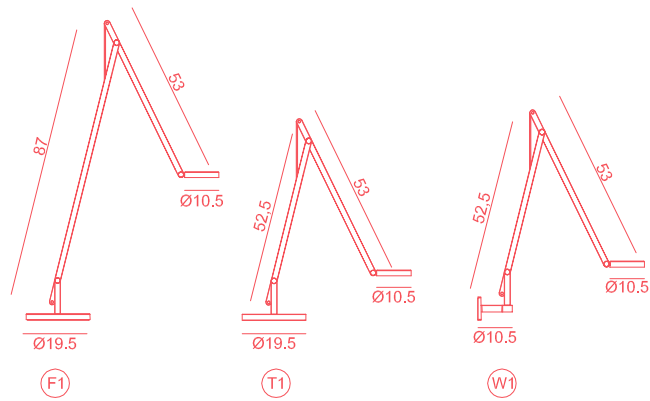
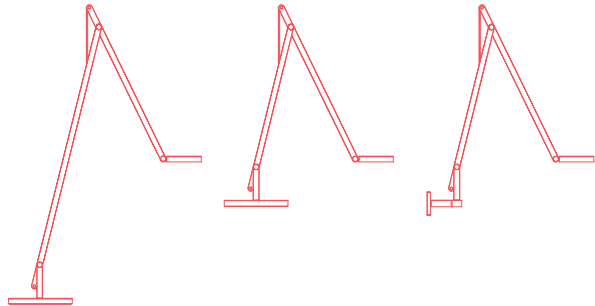

Made in Italy

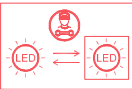

Light Source	MID POWER LED
Power	9 Watt
Kelvin	2.700
Dimmer	push button
Lumen	700
CRI	90



Max 9W	Power
220 / 240 V AC 50Hz	Betriebsspannung
Technische Daten	

	Austausch, Ein-und Ausbau sowie Bedienung der Lampe/Led. Vor jedem Berühren stets den Netzstecker ziehen oder die Lampe vom Stromkreis entfernen. Bei Einrichtung von Hängeluchten/Wandbruchten, wenden Sie sich immer an einen Elektrofachmann.
	Schutzart IP 20. Schutz gegen das Eindringen fester Körper Ø12 mm. Kein Schutz gegen Regenwasser.
	ACHTUNG Das Gerät darf nicht als unsortierter Siedlungsabfall entsorgt werden. Zum Schutz der Umwelt muss es getrennt einer Sammelstelle abgegeben werden. Gemäß der Richtlinie 2012/19/UE und den entsprechenden nationalen Gesetzen über die Entsorgung von Altgeräten ist die Nichterhaltung strafbar. Bitte informieren Sie sich über die örtlichen Sammelstellen für Elektroprodukte und elektronische Geräte.

CE LED IP 20

