

OPZIONI-OPTIONS-OPTIONEN

PALU\* PIEDI IN ALLUMINIO ALUMINIUM FÜSSE ALUMINIUM FEET  
PIEDS D'ALUMINIUM

SFOD RIVESTIMENTO TESSUTO SFODERABILE ABZIEHBARER BEZUG  
IN STOFF REMOVABLE SLIP COVER IN FABRIC REVETEMENT  
TISSU AMOVIBLE



1-Solida struttura in legno. 3-Poliuretano espanso.  
4-Poliuretano espanso in densità e spessori diversi.  
8-Riempimento di piume, stabilizzate a settori.  
9-Poliuretano espanso pregiato. 22-Gambe in fusione di alluminio. 24-Fibra di poliestere accoppiata a tessuto di cotone. 30-Telaio tubolare metallico con cinghie elastiche. 42-Visco foam.

1-Sturdy inner wooden frame. 3-Expanded polyurethane.  
4-Expanded polyurethane in different thickness and densities. 8-Padding with downs, stabilised in sectors.  
9-High-grade expanded polyurethane. 22-Legs of aluminium fusion. 24-Polyester fibre joined with cotton fabric. 30-Tubular metallic frame with elastic straps. 42-Visco foam.

1-Structure in bois solide. 3-Polyuréthane expansé.  
4-Polyuréthane expansé en différent épaisseurs et densités. 8-Garnis de duvet piquagées en secteurs.  
9-Polyuréthane expansé haute qualité. 22-Jambes de fusion d'aluminium. 24-Fibre de polyester avec tissu de coton. 30-Châssis métallique tubulaire avec sangles élastiques. 42-Visco foam.

1-Stabiles Holzgestell. 3-Polyuretanschaum.  
4-Polyuretanschaum in verschiedenen Stärken und Dichten. 8-In Kammern unterteilte Daunenfüllung.  
9-Hochwertiger Polyuretanschaum. 22-FüÙe aus AluminiumguÙ. 24-Polyesterfaser mit Baumwollauflage.  
30-Metallrohrrahmen mit elastischen Gurten. 42-Visco foam.

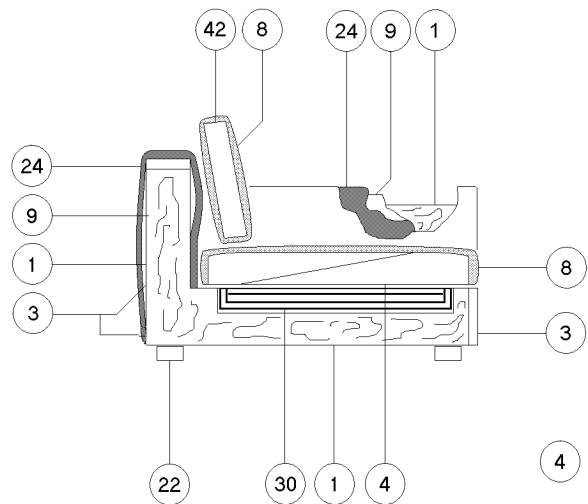

\* Opzione Standard; sarÙ montato qualora non vi siano richieste specifiche nell'ordine  
Standard Option; will be assembled as far as no specific requests are mentioned in the order.  
Option Standard; il sera montÙ, si n'y a pas demandes spÙcifiques sur la commande.  
Standard Option; wird montiert, wenn auf dem Auftrag keine spezifischen AusfÙhrung angegeben ist.

L=Lunghezza,P=Profondità,H=Altezza,Hs=Altezza Seduta,Ps=Profondità Seduta,HBr=Altezza Bracciolo,LBr=Larghezza Bracciolo

L=Lenght,P=Deep,H=Height,Hs=Seat Height,Ps=Seat deep,HBr=Armrest Height,LBr=Armrest Breadth

L=Longueur,P=Profondeur,H=Hauteur,Hs=Hauteur d'assise,Ps=Profondeur d'assise,HBr=Hauteur d'accouider,LBr=Largueur d'accouider

L=Länge,P=Tiefe,H=Höhe,Hs=Sitzhöhe,Ps=Sitztiefe,HBr=Armlehnhöhe,LBr=Armlehnbreite

BRSN-B

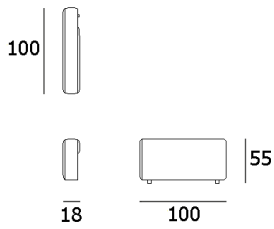

BRDX-B

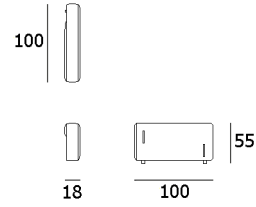

BRSN-A

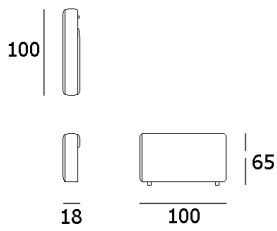

BRDX-A

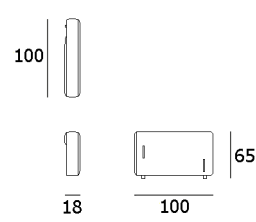

E080

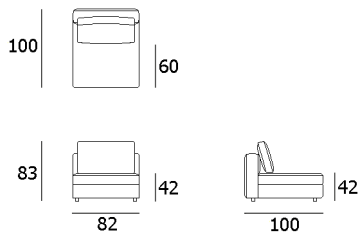

E090

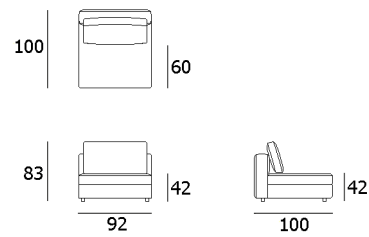

E100

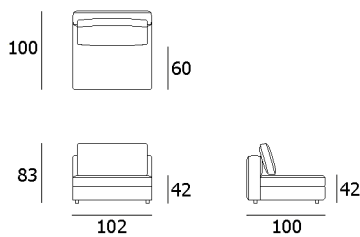

E160

