



*"I started the new project to meet a common request in my professional path, i.e. to design a collection of storage units. But in this case the term common immediately proved to be inappropriate, since I did not begin to deal with a storage unit or furniture company, but more appropriately with a manufacturer of structures. Small mechanical engineering, consisting of details that start from a different research compared to what I consider a "commonness". A rational architecture on a domestic scale; an atypical storage unit project, at least for me. A new experience."*

Rodolfo Dordoni

System of storage units with doors, drawers and open compartments for the different domestic, office and public environment.

### Typology

Collection composed of different storage units in terms of dimensional combinations and frontal equipment:

- **Low** with nominal length L200cm (real L199.5cm), nominal height H80cm (real H79.7cm), depth D50cm. Available with 4 doors or 2 doors, a single drawer and an open compartment or two doors and a double drawer;
- **Medium**, with nominal length L151cm (real L151.2cm), nominal height H116cm (real H115.6cm), depth D50cm. Available with 3 doors or 3 doors and an open compartment.
- **High**, with nominal length L103cm (real L102.9cm), nominal height H152 (real H151.6cm), depth D50cm. Available either with 2 doors or 2 doors and an open compartment.

The open compartment is always provided with a perforated backrest. For the above-mentioned typologies, every storage unit can be customised by choosing between two side panels' options:

- transparent in extra clear glass 5mm thick
- with panel in the same lacquered finish as the structure.

### Structure

Element in lightened and lacquered honeycomb panel. Steel section 30x30x5 mm for the main structure and extruded aluminium for the upper profile.

The project has focused on technical details that complete the storage units. Heron uses an innovative hinge, featuring a slim and compact shape. Inserted into the top and into the door, it remains practically hidden from the view.

Drawers are equipped with full extension guides, with built-in push-pull system in the opening and synchronization bar for a better sliding.

All of the typologies are equipped with lacquered backrest and so they enable the element to be placed in the middle of the room and/or in the back of the sofa.

### Finishes and options

The storage units structure always comes in matt and is in two options available:

- profile in painted metal matt white, with micro-goffered lacquered ivory white panels;
- profile in painted metal matt light grey with micro-goffered lacquered medium grey panels.

Every storage unit can be customised by choosing the colour of the cabinet back panel, in the different matt lacquered options available: ivory white, medium grey, dark red, okra yellow, dark orange and petrol blue.

Cabinet back panel stands for:

- backrest in perforated sheet (on both sides)
- backrest in honeycomb panel in the internal side only
- internal shelves, where expected
- drawer front

# HERON finishes

## FINISH: STRUCTURE PROFILE

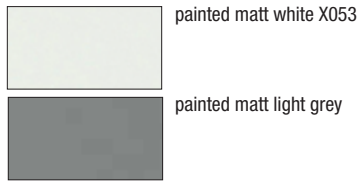

## FINISH: STRUCTURE PANELS

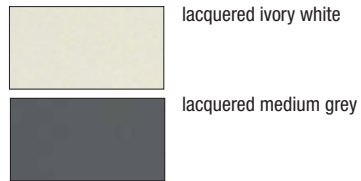

## FINISH: BACK PANEL



profile detail

## FINISH: SIDE PANEL

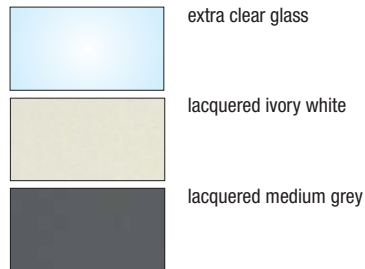

Every storage unit can be customised by choosing between two side panels' options:

- transparent in extra clear glass 5mm thick
- with panel in the same lacquered finish as the structure.

## EXAMPLES OF UNITS WITH SIDE PANELS IN TRANSPARENT GLASS



**LOW UNIT H80 - 4 DOORS**  
**REAL DIMENSIONS H79.7 - L199.5 - D50**

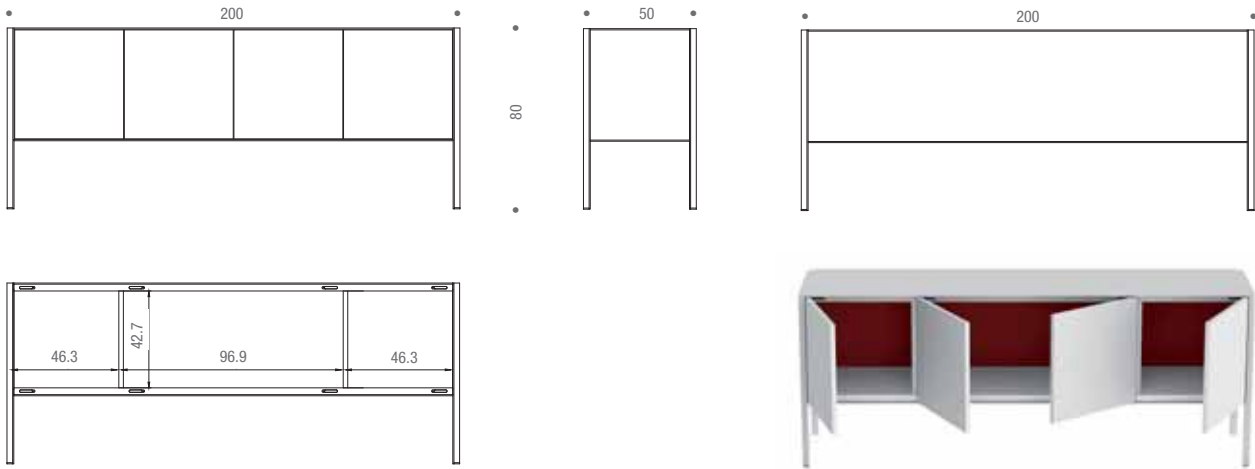

**LOW UNIT H80 - 2 DOORS, SINGLE DRAWER AND AN OPEN COMPARTMENT**  
**REAL DIMENSIONS H79.7 - L199.5 - D50**

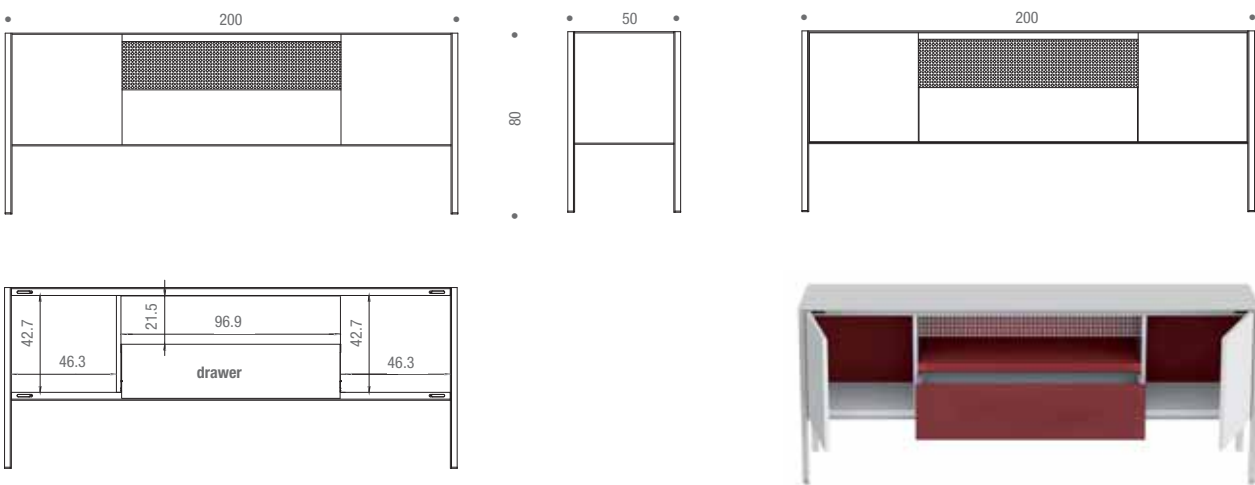

**LOW UNIT H80 - 2 DOORS AND DOUBLE DRAWER**  
**REAL DIMENSIONS H79.7 - L199.5 - D50**

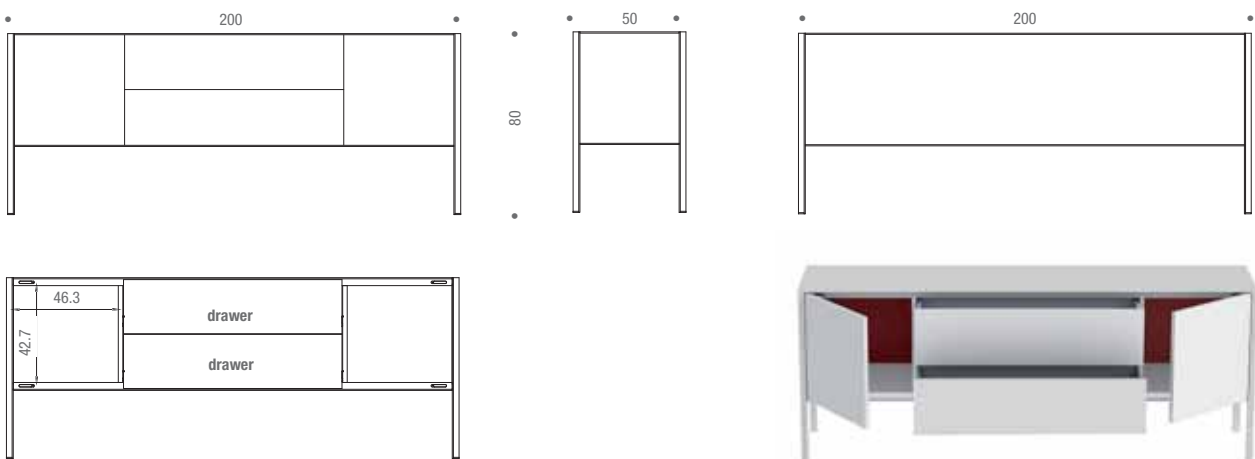

# HERON abacus

## MEDIUM UNIT H116 - 3 DOORS

REAL DIMENSIONS H115.6 - L151.2 - D50

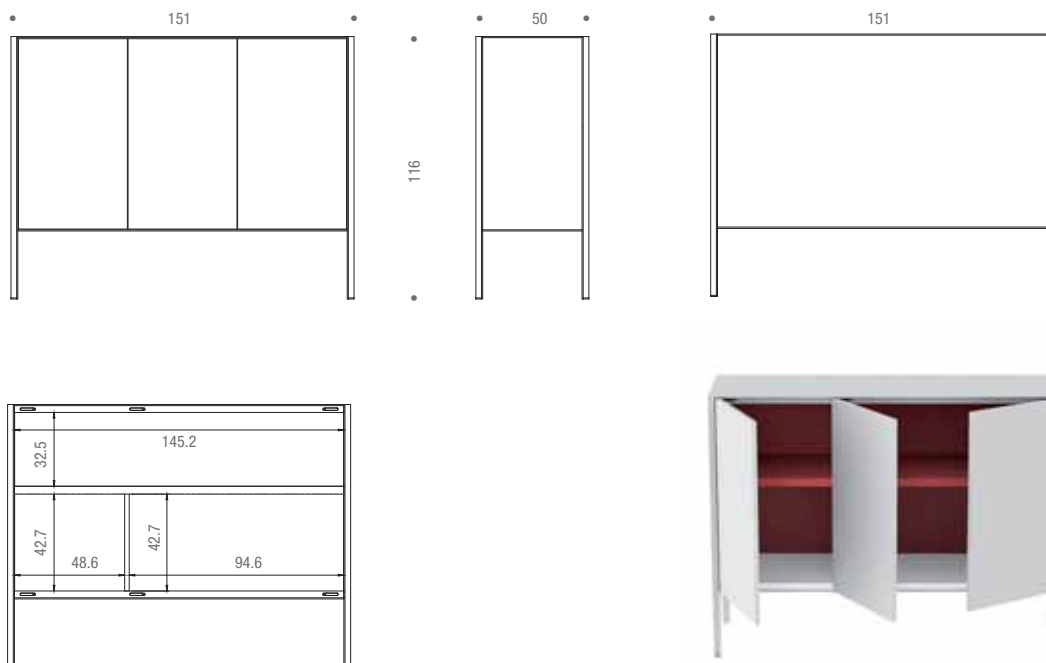

## MEDIUM UNIT H116 - 3 DOORS AND AN OPEN COMPARTMENT

REAL DIMENSIONS H115.6 - L151.2 - D50

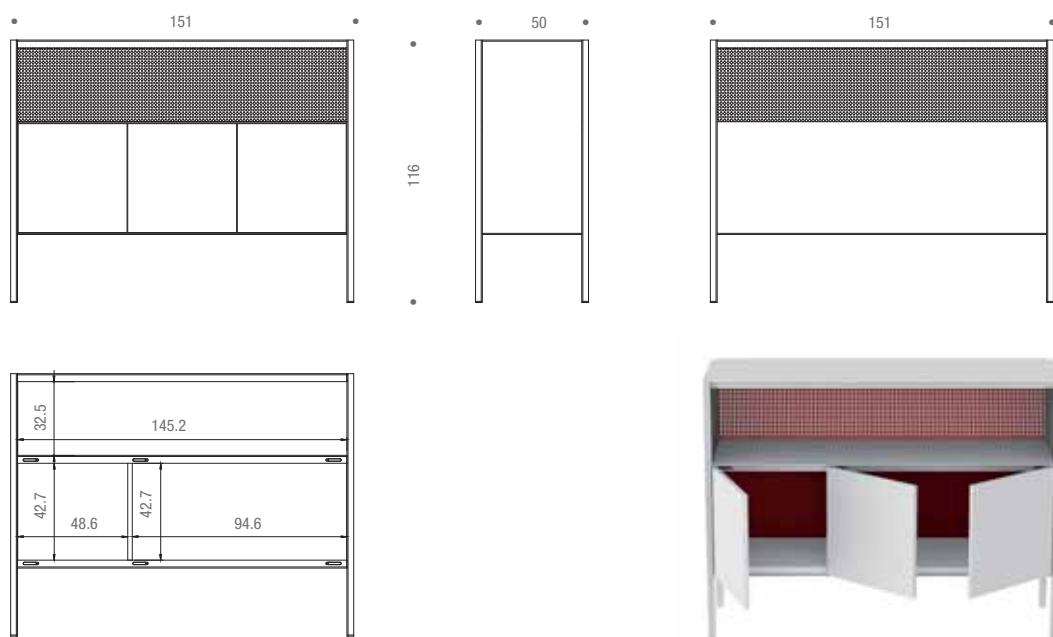

**HIGH UNIT H152 - 2 DOORS**  
**REAL DIMENSIONS H151.6 - L102.9 - D50**

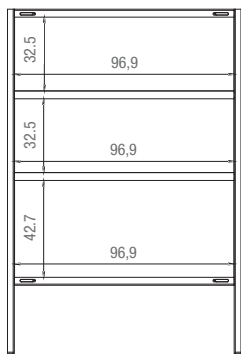
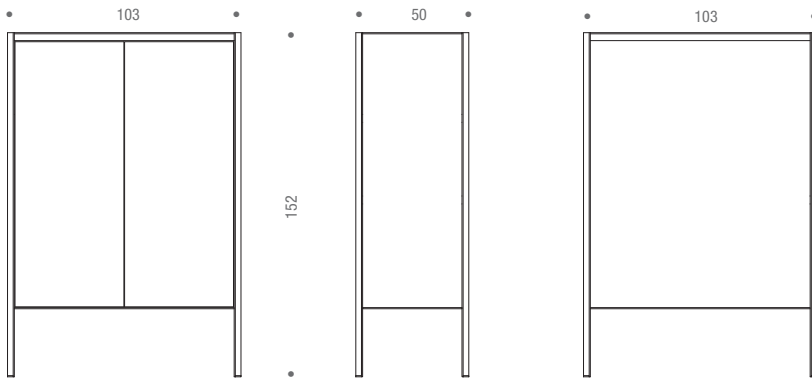

**HIGH UNIT H152 - 2 DOORS AND AN OPEN COMPARTMENT**  
**REAL DIMENSIONS H151.6 - L102.9 - D50**

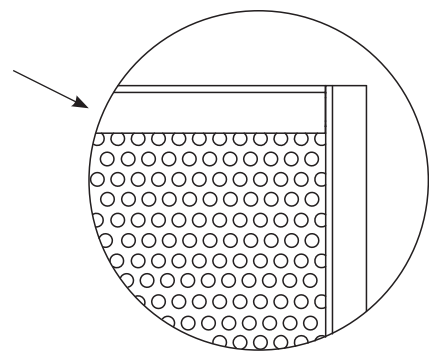
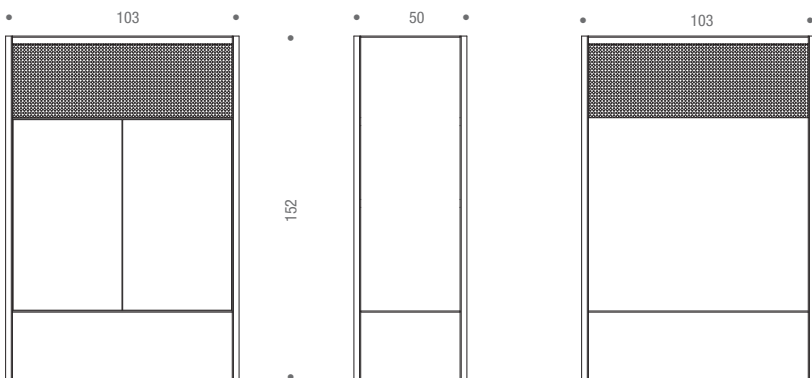

backrest in perforated sheet

