

DAPHNE

design Tommaso Cimini



Light performers



LUMINA
www.lumina.it













Diffusore girevole

Pivoting diffuser
Drehbarer Diffusor





Dimmer



Trasformatore
Transformer
Transformator

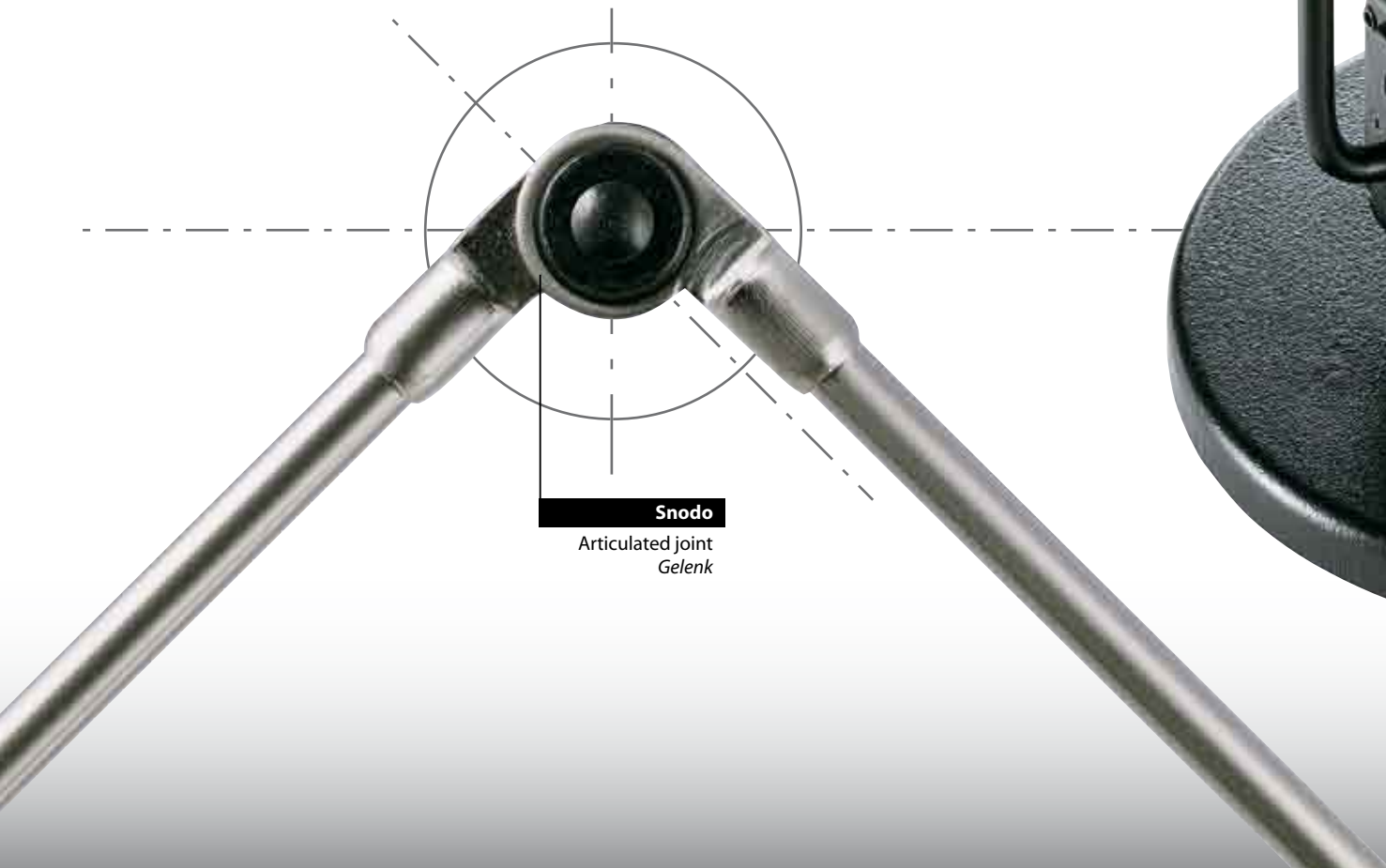

Snodo
Articulated joint
Gelenk

Serie di lampade in metallo con braccio snodato e orientabile: diffusore girevole a 360 gradi. Trasformatore elettronico. Dimmer.

A range of lamps made out of metal, with adjustable arm and 360° rotating head. Electronic transformer. Dimmer.

Produktfamilie aus Metall mit verstellbarem Arm und mit um 360° drehbarem Reflektor. Mit Elektronischem trafo. Dimmer.

IESNA files on www.lumina.it

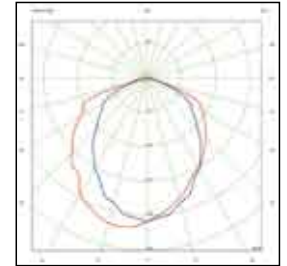

Innesto a scatto

Jack connection
Schnappkupplung

Interruttore a due intensità

Two position switch
Zweistufenschalter





Morsetto max 52 mm
Clamp max 52 mm
Klemme max 52 mm

Trasformatore
Trasformer
Trasformator

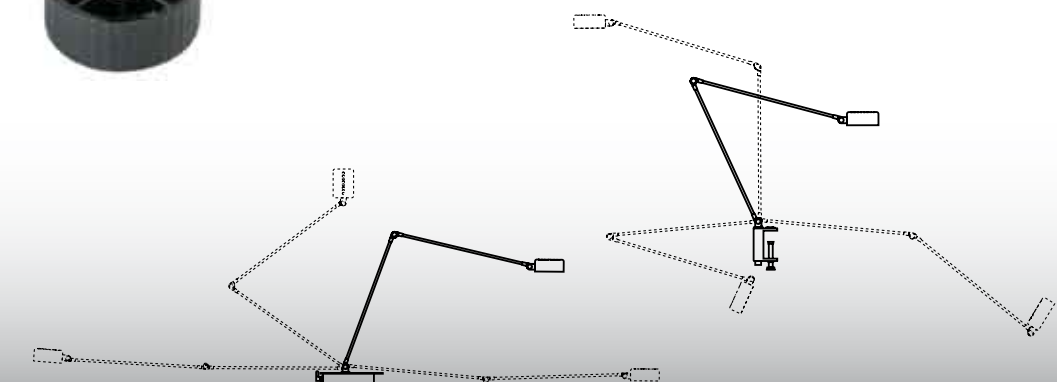



Color 55

● Daphine Parete



Color 44

● Daphine Faretto



● Cloe Morsetto

Color 44



● Daphine Terra

● Cloe



Color 02
Bianco
White
Weiß



● Daphinette

Color 01
Nero
Black
Schwarz



● Daphine



Color 44
Nichelato
Nickled
Vernickelt

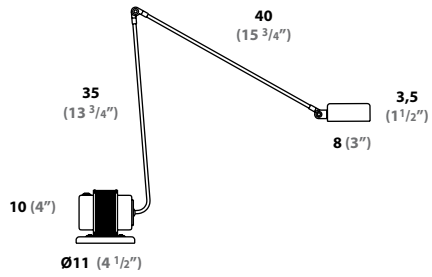





Color 55
Argento metallizzato
Metal silver
Metallic silber



Daphine - Daphine Dimmer* Cod. 01 - 03

12V 50W Hal • GY 6.35



   *Dimmer

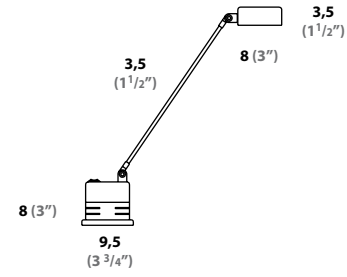



     



Daphinette Cod. 09

12V 20W Hal • G4





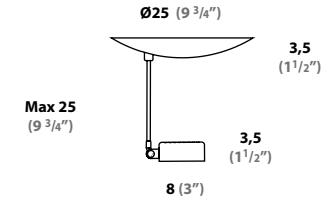





   



Daphine Faretto - Daphine Faretto ST* Cod. 105 - 106

12V 50W Hal • GY 6.35



    * senza trasformatore
without transformer
Ohne Trafo



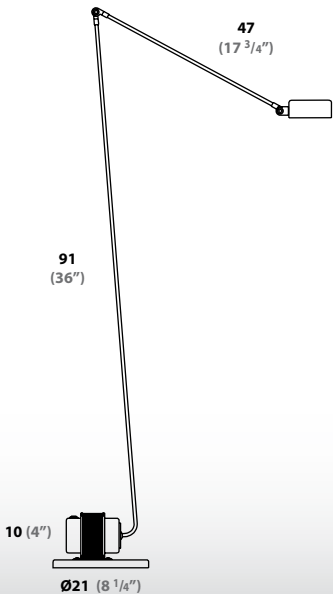



Cod. 106



Daphine Terra - Daphine Terra D* Cod. 02 - 04

12V 50W Hal • GY 6.35



   *Dimmer

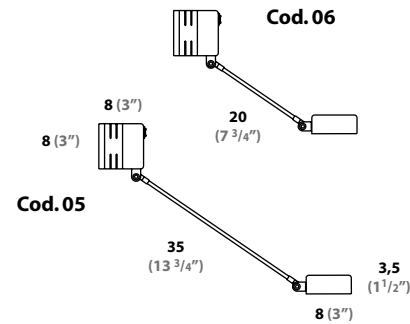



     



Daphine Parete Cod. 05 - 06

12V 20W Hal • G4



  

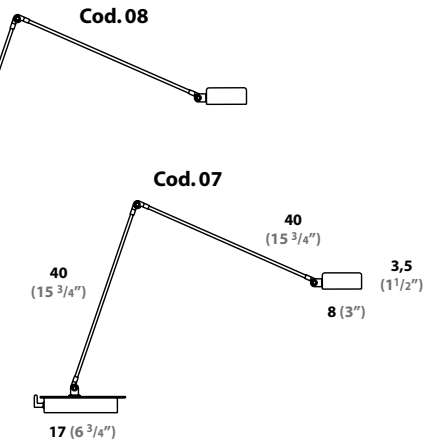



   



Cloe - Cloe Morsetto Cod. 07 - 08

12V 50W Hal • GY 6.35

Cod. 07 Cod.08