

RONDÒ | 90 height-adjustable

Romano Marcato | 2007



RONDÒ

Romano Marcato | 2007

A column with a world around it. The RONDÒ table harmoniously develops a minimalist theme, with a central support for the tabletop. Its profile is rounded, also in the square version. Its adjustable height and colour choices, from rigorous black and white to the warm appeal of wood, create a host of solutions offering sheer elegance.



RONDO

Romano Marcato | 2007

| 90 height-adjustable table Ø90 90x90 H68÷106

Height adjustable table with block-lift system. Zinc plated base covered with a stainless steel sheet Aisi304 "linen fabric" pattern or entirely powder coated. The adjustable leg with plate to fix the top are powder coated. Top in plywood of birch oak veneered or with laminate and visible plywood edge. Top also available in HPL 10 mm. or lacquered MDF. Felt under the base.

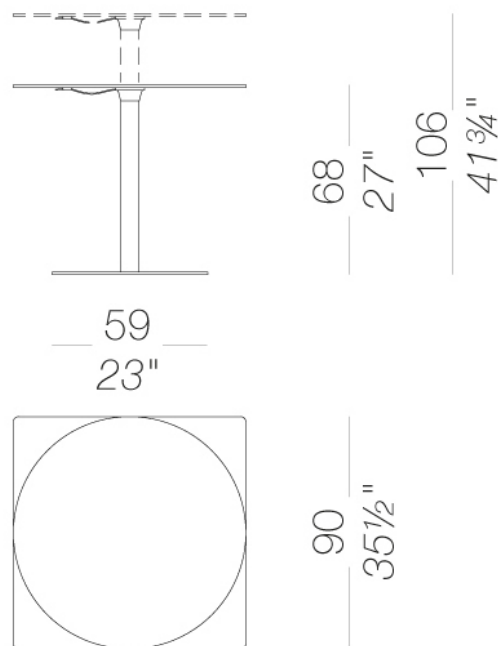

RONDÒ | 90 height-adjustable

Romano Marcato | 2007

base



powder coating
black
1 Colors

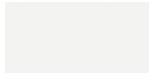

powder coating
white
1 Colors

leg



powder coating
black
1 Colors



powder coating
white
1 Colors

top



HPL 10 mm
HPL H406
1 Colors



HPL 10 mm
black HPL fenix
1 Colors

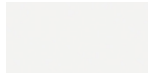

HPL 10 mm
white HPL fenix
1 Colors

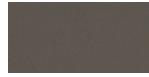

HPL 10 mm
HPL fenix grigio
Londra
1 Colors



HPL 10 mm
HPL fenix rosso
Jaipur
1 Colors



wood
blanch oak
1 Colors

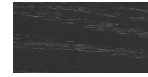

wood
black open pore
1 Colors



wood
oak dark walnut
1 Colors

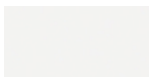

lacquered
white lacquered
1 Colors

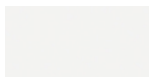

laminate
406 abet 9/10
1 Colors

consult the portfolio for the range of colors, fabrics, eco-leather, soft-leather.

use and maintenance instructions

Clean all parts in wood, leather, fabric and metal with a damp cloth or a diluted neutral cleaner. Do not use cleaners with alcohol, bleach, solvent or abrasive products. Any liquid spilt on the product must be wiped up immediately. When lifting or moving the product, hold it on the structure and not under the seat. The product should not be subjected to unbalanced weights, as it is designed for a proper rest on the foothold (on four legs or on the base). Our company relieves from any responsibility in case of damage caused to fragile floors. Avoid any improper use of the product: do not step on the product, on the footrest or on the armrests. Avoid any movements that could compromise the proper functionality of the product or the safety of the users. Wood and leather, being natural materials, could be easily damaged. Small impurities or imperfections are within quality standard range. Do not expose the product to weather conditions or atmospheric agents, nor to heat sources over 40°C. Also products for outdoor use could be afflicted by atmospheric agents. The product could undergo possible exterior changes due to particular exposure to heat, humidity and saltiness. An appropriate and frequent maintenance and cleaning of the product enhances its durability. The product could change colour and shade, if exposed to direct sunlight. Maintenance has to be carried out by experienced staff. Dispose of the package only after assembling the product, in order to avoid the loss of ironmongery and components. Once the product has been dismantled, the product itself or its components must be given to the public garbage disposal system, according to the legislation in force.