

## Neat

Designer Christophe Pillet

This collection of tables is ideal for any space and use: from the office to home areas. It has an aluminium structure, always with an integrated cable holder, and a marine plywood top faced with epoxy-lacquered sheet metal, with an attractive textured finish.

### Leg finish:

Aluminium with white lacquer

### Finish of top:

Steel painted white

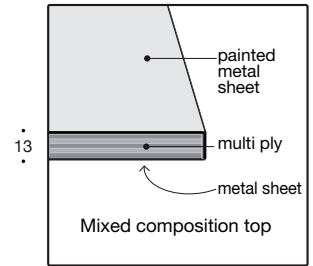

Code	Measures (cm.)	Finish of legs	Finish of top	Vol.
01NEA03F	160 x 90	lacquer	lacquer	0.34
01NEA04F	180 x 90	lacquer	lacquer	0.38
01NEA05F	200 x 90	lacquer	lacquer	0.41
01NEA06F	220 x 90	lacquer	lacquer	0.45
01NEA07F	240 x 90	lacquer	lacquer	0.48
01NEA30F	200 x 100	lacquer	lacquer	0.45
01NEA31F	220 x 100	lacquer	lacquer	0.49
01NEA32F	240 x 100	lacquer	lacquer	0.53
01NEA33F	260 x 100	lacquer	lacquer	0.57
01NEA34F	280 x 100	lacquer	lacquer	0.61

Nr. packages 1

### Optionals

Code	Description
02FOR02	lateral or central cable hole

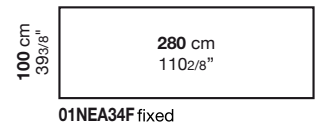
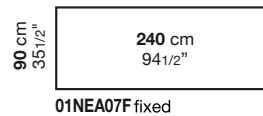
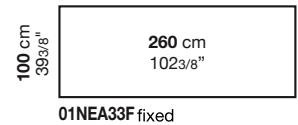
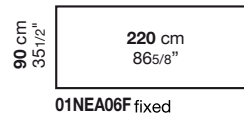
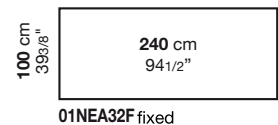
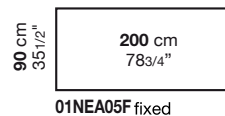
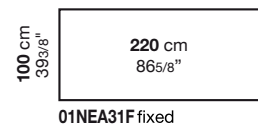
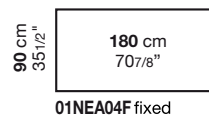
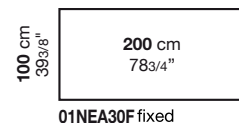
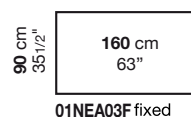
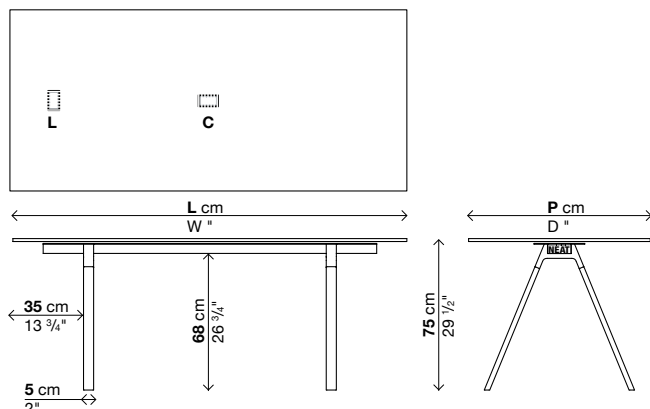

## Finishes



**Bianco** / White / Weiß / Blanco / Blanc